

UPS Cabinet

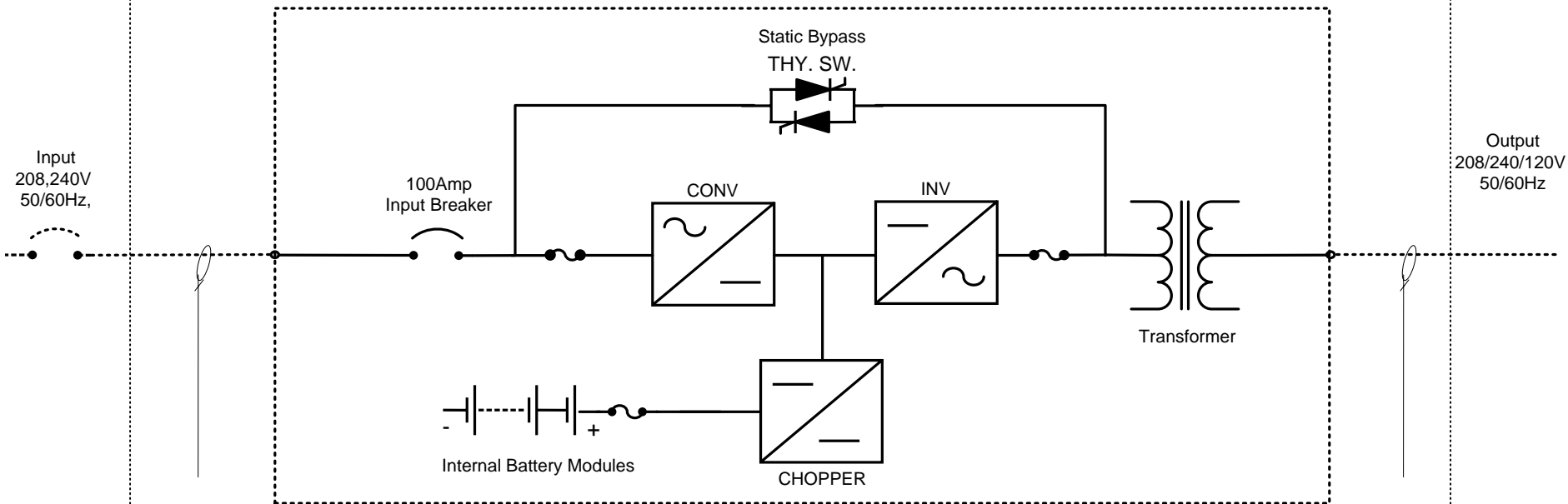

Hardwire Configuration

1	2	3	4	5	6	7	8	11	12	13	14	15	16	17
L1	L2	G	X1	X2	N	X3	G	208	COM	240	EPO1	EPO2	REMOTE	

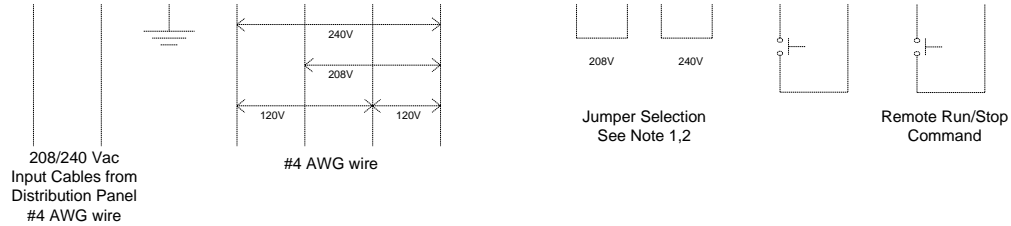

NOTES

1. If AC input power is 240Vac rated, terminals 12 and 13 must be shorted by jumper wire
2. If AC input power is 208Vac rated, terminals 11 and 12 must be shorted by jumper wire (factory set)

DRAWN BY	DATE
JE	10/11/05
APPROVED	DATE
GM	10/11/05

TOSHIBA
INTERNATIONAL CORPORATION
Houston Texas, USA

THIS MATERIAL IS THE EXCLUSIVE PROPERTY OF TOSHIBA INTERNATIONAL CORPORATION AND SHALL NOT BE REPRODUCED, USED, OR DISCLOSED TO OTHERS UNLESS PRIOR WRITTEN AUTHORIZATION IS OBTAINED.

TITLE	
1600 EP Series 14 kVA Model 208/240V Input 208/240/120V Output	
DRAWING NO.	REV.
UE3G2L140C61T	1.0